

SURFACE MOUNT CERAMIC CHIP CAPACITORS

HIGH-REL INDUSTRIAL

HIGH-REL MILITARY

HIGH-REL SPACE

HIGH VOLTAGE

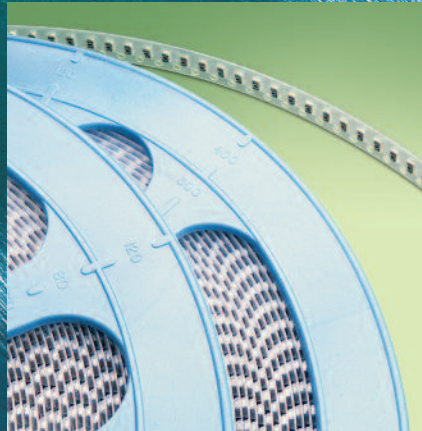
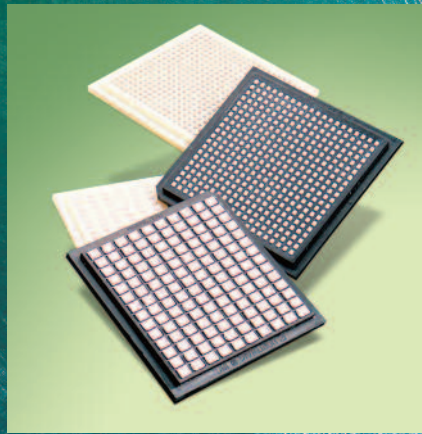

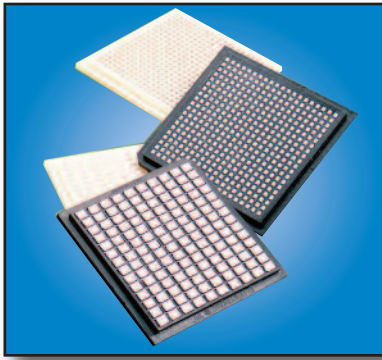

PRESIDIO COMPONENTS, INC.

OUTSTANDING CUSTOMER SERVICE AND EXPERIENCE YOU CAN TRUST

Presidio Components has been an industry leader in the manufacture of ceramic capacitors since 1980. We are dedicated to excellence in manufacturing, process control and customer service. All products are manufactured and tested in our state-of-the-art, 90,000 square foot facility in San Diego, California, allowing for immediate response to your business needs. We have numerous patents, and hundreds of years of combined engineering experience, and we can formulate the right product for your application. At Presidio Components we work hard to build positive, long term relationships with our customers and we will go the extra distance to ensure customer satisfaction.

PRESIDIO PRODUCT LINES

If you have a demanding application, please call the factory. We are easy to reach. Although Presidio Components maintains more than 100 million commercial and military parts in inventory, we can help with multitudes of intermediate sizes, voltages, tolerances, termination finishes, lead-frame styles and more. Some of our specialties include ceramic capacitors for high temperatures, cryogenic temperatures, and pulse discharge applications, as well as high Q dielectric, negative and positive temperature characteristic and piezoelectric ceramic formulations. We also have a series of ceramic capacitors for microwave and RF applications, including wirebondable single layer, wirebondable bypass, and SMD broadband DC blocking caps.

For more information about Presidio's products or the name of your local sales representative visit our website at:

<https://presidiocomponents.com>

Diverse Markets

Presidio Components provides ceramic capacitors for high quality industrial, military and space applications. Our customers manufacture products such as aircraft, missile guidance systems, switch mode power supplies, phased array radar, high frequency transponders and receivers, and ring laser gyros.

QPL Products & DLA Approved Test Lab

Presidio Components was initially qualified to MIL-PRF-55681 in 1984. Since then we have upgraded our processing line to obtain the highest established reliability rating of "S" level. We are also qualified on two additional space level specifications, MIL-PRF-123 and MIL-PRF-49470 "T" level. And, Presidio Components is proud to be the first QPL supplier to MIL-PRF-49467, the high voltage ceramic capacitor specification. All QPL testing per MIL-STD-202 is done on site at our DLA approved test lab. For a list of environmental test capability, consult the factory.

**MIL-STD-790 DLA APPROVED
FACILITY AND TEST LAB
CAGE CODE: 60212**



 **PRESIDIO COMPONENTS, INC.**

7169 Construction Court, San Diego, CA 92121 • Tel: 1+858-578-9390 • Fax: 1+858-578-6225
www.presidiocomponents.com • email: info@presidiocomponents.com

TABLE OF CONTENTS

Commercial, Industrial and High Reliability “HR” Capacitors	4-5
High Reliability “CR” Capacitors.	6-7
High Reliability “SR” Capacitors.	8-9
Space Series SR#M123A Series Surface Mount Ceramic Chip Capacitors	10 & 11
SR#N1, HR#N2, HR#N3 Series Following EEE-INST-002 Level 1, 2, & 3	12
Military & Space Qualifications & DLA Drawings	13
High Voltage Ceramic Capacitors.	14 & 15
Low Inductance Capacitors & Other Available Sizes	16
How to Order CDR QPL Military Parts (Mil-PRF-55681 and M123).	17
MIL-PRF-55681 CDR Chip Capacitors	18
MIL-PRF-123 CKS Chip Capacitors	19

HOW TO ORDER A PRESIDIO PART

EXAMPLE: SR0402X7R104KENT91

SR	0402	X7R	104	K	E	NT9	1	—	—
Prefix			Capacitance Code		Voltage Code			Suffix	
Blank for Commercial/Industrial (See Page 4&5) HR (see page 4&5) CR (see page 6&7) SR (see page 8&9) For Engineering Units we recommend our HR Series			Two significant figures followed by the number of zeros Example OR1 = 0.1 pF 1R0 = 1.0 pF 100 = 10 pF 101 = 100 pF 102 = 1000 pF 103 = .01 μF 104 = .10 μF 105 = 1.0 μF		B = 5 VDC C = 6.3 VDC E = 10 VDC F = 12 VDC G = 16 VDC H = 20 VDC 1 = 25 VDC 2 = 50 VDC L = 75 VDC 3 = 100 VDC A = 150 VDC 4 = 200 VDC & = 250 VDC 5 = 300 VDC 6 = 500 VDC 7 = 600 VDC 8 = 750 VDC 9 = 1000 VDC 10 = 1500 VDC 11 = 2000 VDC 12 = 2500 VDC 13 = 3000 VDC 14 = 4000 VDC 15 = 5000 VDC 16 = 6000 VDC 17 = 7000 VDC 18 = 8000 VDC 19 = 9000 VDC 20 = 10,000 VDC 21 = 11,000 VDC 22 = 12,000 VDC 23 = 15,000 VDC 24 = 20,000 VDC 25 = 25,000 VDC 30 = 30,000 VDC 40 = 40,000 VDC 50 = 50,000 VDC		Add “A” for non-standard dimensions. Leave blank for standard dimensions.		
	Size Code								
	See tables for sizes								
		Dielectric Code		Tolerance Code			Packaging and Marking		
		BP NPO (1) N2T BX BR BQ X7R Y5V Consult factory for electrical characteristics. (1) NPQ and UP are older names for our High Q NPO but are still supported.		A = ± .05 pF < 10 pF B = ± .10 pF < 10 pF C = ± .25 pF < 10 pF D = ± .50 pF < 10 pF E = ± 0.5% ≥ 10pF F = ± 1% ≥ 10pF G = ± 2% ≥ 10pF J = ± 5% ≥ 10pF K = ± 10% L = +20/-10% M = ± 20% Z = +80/-20% P = +100/-0%	BP NPO	<ol style="list-style-type: none"> 1. Reel, 7", plastic tape, unmarked 2. Reel, 7", plastic tape, marked 5. Waffle, unmarked 6. Waffle, marked A. Reel, 13", plastic tape, unmarked C. Reel, 7", paper, unmarked (0402 & 0603 only) <p style="text-align: center;">Marking available for size 0805 or larger (extra cost)</p> <p style="text-align: center;">Please contact factory or visit link below: http://presidiocomponents.com/PackagingCodes.pdf</p>			
							Termination Code	RoHS Compliant Code	
							NT9 = Plated SnPb over Ni Min 4% Pb P = PdAg (Thick Film Palladium Silver) H = Au (Thick Film Gold) NG* = Plated Au over Ni (for legacy parts primarily, contact factory) T = Plated Sn over Ni P, F & H Terminations are Non-Magnetic. Other Terminations Available	Blank = Non-RoHS R = RoHS Compliant Terminations P, F, H, NG & T are RoHS compliant	

Consult factory for Y5V Dielectric, other voltages, capacitance options and parts outside a given range.

Please feel free to contact our Engineering Team.

We are easy to reach and eager to help you select the right part numbers for your application.



COMMERCIAL AND INDUSTRIAL CERAMIC CAPACITORS

Presidio provides high quality ceramic capacitors for a wide variety of industrial applications. Every component must pass the test criteria listed below.

QUALITY ASSURANCE PROVISIONS

Every lot undergoes the following inspection and tests:

a) Capacitance — All parts are tested at 25°C and 1VACRMS in accordance with Method 305 of MIL-STD-202. Y5V and low voltage parts follow EIA guidelines.

b) Dissipation Factor (DF) — See following table:

Voltage Rating	NPO	BX/BR	X7R	Y5V
10	N/A	5.0%	7.5%	13%
16	.15%	5.0%	7.5%	13%
25	.15%	3.5%	5.0%	13%
50	.15%	2.5%	3.5%	10%
> 50	.15%	2.5%	2.5%	10%

c) Dielectric Withstanding Voltage (DWV) — All parts are tested to EIA/MIL standards.

d) Insulation Resistance (IR @ 25°C) — All parts are tested at 25°C and rated voltage in accordance with Method 302 of MIL-STD-202. The minimum IR required is 100,000 megohms or 1,000 megohm-microfarads.

e) Visual — Performed on pieces in accordance with Presidio internal workmanship criteria.

f) Mechanical — Level 1 AQL 1% in accordance with this catalog.

g) Operating Temperature Range: -55°C to +125°C

EXAMPLE PART NUMBER

0402X7R104KENT91

See Page 3

“HOW TO ORDER A PRESIDIO PART”

HIGH RELIABILITY “HR” CAPACITORS

For applications where reliability, but not full military screening is required, Presidio recommends its high reliability “HR” capacitors. The “HR” code signifies use of the test program below, or the use of a customer Source Control Document (SCD) that includes voltage conditioning.

QUALITY ASSURANCE PROVISIONS

Every lot undergoes the following inspection and tests:

a) Voltage Conditioning — All parts receive a voltage conditioning at 2X rated voltage and 125°C for a minimum of 8 hours. An accelerated voltage conditioning, following MIL-PRF-55681 guidelines, may be used at Presidio’s discretion.

b) Capacitance — All parts are tested at 25°C and 1VACRMS in accordance with Method 305 of MIL-STD-202.

c) Dissipation Factor (DF) — See following table:

Voltage Rating	NPO	BX/BR	X7R	Y5V
10	N/A	5.0%	7.5%	13%
16	.15%	5.0%	7.5%	13%
25	.15%	3.5%	5.0%	13%
50	.15%	2.5%	3.5%	10%
> 50	.15%	2.5%	2.5%	10%

d) Dielectric Withstanding Voltage (DWV) — All parts are tested at 2.5X rated voltage in accordance with Method 301 of MIL-STD-202, or according to EIA/MIL Standards.

e) Insulation Resistance (IR @ 25°C) — All parts are tested at 25°C and rated voltage in accordance with Method 302 of MIL-STD-202. The minimum IR required is 100,000 megohms or 1,000 megohm-microfarads.

f) Visual — Performed on pieces in accordance with Presidio internal workmanship criteria.

g) Mechanical — Level 1 AQL 1% in accordance with this catalog.

h) Operating Temperature Range: -55°C to +125°C

i) (Optional) Class H Element Evaluation per MIL-PRF-38534 Rev L — Must be specified on the RFQ and Purchase Order (charge will apply). Data package included.

CERTIFICATE OF COMPLIANCE

A Certificate of Compliance will be sent with each shipment.

STANDARD PACKAGING

Product will be packaged in individual waffle trays or tape and reel as specified by customer.

Visit Presidio’s website for additional technical information on these products.

EXAMPLE PART NUMBER
HR0402X7R104KENT91

Add “HR” to the beginning of the standard Presidio part number. See Page 3 “HOW TO ORDER A PRESIDIO PART”

THE HR SERIES IS OFTEN USED FOR ENGINEERING UNITS.



7169 Construction Court, San Diego, CA 92121 • Tel: 1+858-578-9390 • Fax: 1+858-578-6225
www.presidiocomponents.com • email: info@presidiocomponents.com

COMMERCIAL, INDUSTRIAL AND "HR" CERAMIC CAPACITORS

SIZE	L inches (mm)	W inches (mm)	THICKNESS MAX. (T) inches (mm)	METALIZATION BAND (M.B.) inches (mm)	VVDC	DIELECTRIC			
						NPO	BX/BR	X7R	Y5V
0201	0.024 (0.61) ± 0.003 (0.08)	0.011 (0.28) ± 0.001 (0.03)	0.013 (0.33)	0.004 (0.10) min. band .008(0.20) min. space	10 V	Contact Factory	Contact Factory	0.01 µF	Contact Factory
						10 V	390 pF	6800 pF	0.10 µF
0402	0.040 (1.02) ± 0.004 (0.10)	0.020 (0.51) ± 0.004 (0.10)	0.024 (0.61)	0.004 (0.10) min. band 0.015 (0.38) min. space	16 V	200 pF	3300 pF	0.010 µF	0.027 µF
					25 V	120 pF	2200 pF	4700 pF	0.018 µF
					50 V	100 pF	1800 pF	3900 pF	0.012 µF
					100 V	39 pF	680 pF	1200 pF	5600 pF
					10 V	1200 pF	0.020 µF	0.047 µF	0.12 µF
0403	0.040 (1.02) ± 0.010 (0.25)	0.030 (0.76) ± 0.010 (0.25)	0.03 (0.76)	0.004 (0.10) min. band 0.015 (0.38) min. space	16 V	560 pF	0.012 µF	0.022 µF	0.068 µF
					25 V	390 pF	6800 pF	0.015 µF	0.047 µF
					50 V	330 pF	5600 pF	0.012 µF	0.033 µF
					100 V	68 pF	1000 pF	2200 pF	6800 pF
					10 V	2700 pF	0.068 µF	0.12 µF	0.39 µF
0504	0.050 (1.27) ± 0.010 (0.25)	0.040 (1.02) ± 0.010 (0.25)	0.04 (1.02)	0.005 (0.13) min. band 0.015 (0.38) min. space	16 V	1800 pF	0.039 µF	0.082 µF	0.22 µF
					25 V	1500 pF	0.027 µF	0.047 µF	0.12 µF
					50 V	1200 pF	0.020 µF	0.039 µF	0.082 µF
					100 V	180 pF	2700 pF	6800 pF	0.018 µF
					10 V	2200 pF	0.039 µF	0.22 µF	
0603	0.063 (1.60) ± 0.006 (0.15)	0.032 (0.81) ± 0.006 (0.15)	0.035 (0.89)	0.005 (0.13) min. band 0.025 (0.64) min. space	16 V	1000 pF	0.020 µF	0.10 µF	0.12 µF
					25 V	680 pF	0.015 µF	0.027 µF	0.082 µF
					50 V	560 pF	0.010 µF	0.022 µF	0.056 µF
					100 V	100 pF	1800 pF	3300 pF	0.010 µF
					10 V	4700 pF	0.1 µF	1.0 µF	
0805	0.080 (2.03) ± 0.010 (0.25)	0.050 (1.27) ± 0.010 (0.25)	0.055 (1.40)	0.020 (0.51) ± 0.010 (0.25)	16 V	3300 pF	0.075 µF	0.22 µF	0.47 µF
					25 V	2700 pF	0.047 µF	0.10 µF	0.27 µF
					50 V	2200 pF	0.039 µF	0.10 µF	0.18 µF
					100 V	560 pF	8200 pF	0.022 µF	0.056 µF
					10 V	0.012 µF	0.25 µF	1.8 µF	
1206	0.126 (3.20) ± 0.008 (0.20)	0.063 (1.60) ± 0.008 (0.20)	0.059 (1.50)	0.020 (0.51) ± 0.010 (0.25)	16 V	8200 pF	0.2 µF	0.39 µF	1.2 µF
					25 V	6800 pF	0.15 µF	0.27 µF	0.82 µF
					50 V	5600 pF	0.1 µF	0.22 µF	0.56 µF
					100 V	1500 pF	0.027 µF	0.068 µF	0.18 µF
					200 V	820 pF	0.012 µF	0.027 µF	N/A
1209	0.125 (3.18) ± 0.010 (0.25)	0.095 (2.41) ± 0.010 (0.25)	0.065 (1.65)	0.020 (0.51) ± 0.010 (0.25)	10 V	0.018 µF	0.39 µF	2.7 µF	
					16 V	0.012 µF	0.27 µF	0.68 µF	1.8 µF
					25 V	0.010 µF	0.22 µF	0.47 µF	1.5 µF
					50 V	8200 pF	0.18 µF	0.39 µF	1.2 µF
					100 V	3900 pF	0.068 µF	0.15 µF	0.47 µF
1712	0.175 (4.45) ± 0.015 (0.38)	0.125 (3.18) ± 0.010 (0.25)	0.065 (1.65)	0.020 (0.51) ± 0.010 (0.25)	200 V	1800 pF	0.033 µF	0.068 µF	N/A
					10 V	0.039 µF	0.82 µF	1.8 µF	5.6 µF
					16 V	0.027 µF	0.56 µF	1.2 µF	3.9 µF
					25 V	0.022 µF	0.47 µF	1.0 µF	2.7 µF
					50 V	0.015 µF	0.27 µF	0.68 µF	1.8 µF
1812	0.180 (4.572) ± 0.015 (0.38)	0.125 (3.18) ± 0.015 (0.38)	0.080 (2.03)	0.020 (0.51) ± 0.010 (0.25)	10 V	N/A	N/A	4.7 µF	N/A
					10 V	0.082 µF	2.0 µF	3.9 µF	12.0 µF
1725	0.175 (4.45) ± 0.015 (0.38)	0.250 (6.35) ± 0.018 (0.46)	0.065 (1.65)	0.020 (0.51) ± 0.010 (0.25)	16 V	0.068 µF	1.5 µF	3.3 µF	8.2 µF
					25 V	0.056 µF	1.2 µF	2.2 µF	6.8 µF
					50 V	0.039 µF	0.82 µF	1.8 µF	4.7 µF
					100 V	0.018 µF	0.33 µF	0.68 µF	2.0 µF
					200 V	8200 pF	0.12 µF	0.27 µF	N/A
2225	0.220 (5.59) ± 0.015 (0.38)	0.250 (6.35) ± 0.018 (0.46)	0.08 (2.03)	0.020 (0.51) ± 0.010 (0.25)	10 V	0.10 µF	2.2 µF	4.7 µF	15.0 µF
					16 V	0.082 µF	1.8 µF	3.9 µF	12.0 µF
					25 V	0.068 µF	1.5 µF	3.3 µF	10.0 µF
					50 V	0.056 µF	1.0 µF	2.2 µF	6.8 µF
					100 V	0.027 µF	0.47 µF	1.0 µF	2.7 µF
200V	0.012 µF	0.22 µF	0.47 µF	N/A					

HOW TO ORDER COMMERCIAL, INDUSTRIAL & "HR" CAPACITORS (See p. 3, Example: HR805X7R104K2NT91)

HR	0805	X7R	104	K	2	NT9	1	—
Prefix Leave blank for industrial parts.	Case Size	Dielectric Code	Capacitance Code 0.1 µF	Tolerance Code ± 10%	Voltage Code 50 V	Termination Code Ni/SnPb	Marking & Packaging Reel, unmarked	Blank = Non-RoHS R = RoHS Compliant



HIGH RELIABILITY “CR” CAPACITORS

(TESTED SIMILARLY TO MIL-PRF-55681)

For applications that require a high level of reliability, Presidio recommends its high reliability “CR” capacitors. Tested similarly to MIL-PRF-55681 Group A, Presidio manufactures these chips on the same manufacturing line as its military product line. They may be used in both industrial and military applications. Please note these capacitors are NOT MIL-qualified.

QUALITY ASSURANCE PROVISIONS

Every lot undergoes the following inspection and tests:

- a) **Destructive Physical Analysis (DPA)** — A 32-piece sample is pulled from each lot and examined per relevant sections of EIA 469 and to verify adherence to Presidio’s internal design criteria.
- b) **Voltage Conditioning** — All parts receive a voltage conditioning at 2X rated voltage and 125°C for 100 hours. An accelerated voltage conditioning, following MIL-PRF-55681 guidelines, may be used at Presidio’s discretion.
- c) **Capacitance** — All parts are tested at 25°C and 1VACRMS in accordance with method 305 of MIL-STD-202.
- d) **Dissipation Factor (DF)** — See following table:

Voltage Rating	NPO	BX/BR	X7R	Y5V
10	N/A	5.0%	7.5%	13%
16	.15%	5.0%	7.5%	13%
25	.15%	3.5%	5.0%	13%
50	.15%	2.5%	3.5%	10%
> 50	.15%	2.5%	2.5%	10%
- e) **Dielectric Withstanding Voltage (DWV)** — All parts are tested at 2.5X rated voltage in accordance with Method 301 of MIL-STD-202, or according to EIA/MIL Standards.
- f) **Insulation Resistance (IR @ 25°C)** — All parts are tested at 25°C and rated voltage in accordance with Method 302 of MIL-STD-202. The minimum IR required is 100,000 megohms or 1,000 megohm-microfarads.
- g) **Percent Defective Allowed (PDA)** — The cumulative PDA after voltage conditioning is 8%. Pieces rejected as out of tolerance for capacitance or visual screening will be removed from the lot but not counted in the PDA calculation.
- h) **Visual** — Performed on pieces in accordance with Presidio internal workmanship criteria.

- i) **Mechanical** — Level 1 AQL 1% in accordance with this catalog.
- j) **Operating Temperature Range:** -55°C to +125°C
- k) **(Optional) Class H Element Evaluation per MIL-PRF-38534 Rev L** — Must be specified on the RFQ and Purchase Order (charge will apply). Data package included.

STANDARD PACKAGING

Product will be packaged in individual waffle trays or tape and reel as specified by customer.

DATA PACKAGE

Data will be sent with each shipment including:

- a) **Certificate of Compliance** — A Certificate of Compliance will be sent with each shipment.
- b) **(Optional) Destructive Physical Analysis Report** — Destructive Physical Analysis (DPA) report and photographs for each lot. Extra charge may apply.
- c) **(Optional) Class H Element Evaluation per MIL-PRF-38534 Rev L** — Must be specified on the RFQ and Purchase Order (charge will apply). Data package included.

EXAMPLE PART NUMBER
CR0402X7R104KENT91

Add “CR” to the beginning of the standard Presidio part number. See Page 3 “HOW TO ORDER A PRESIDIO PART”

Visit Presidio’s website for additional technical information on these products.

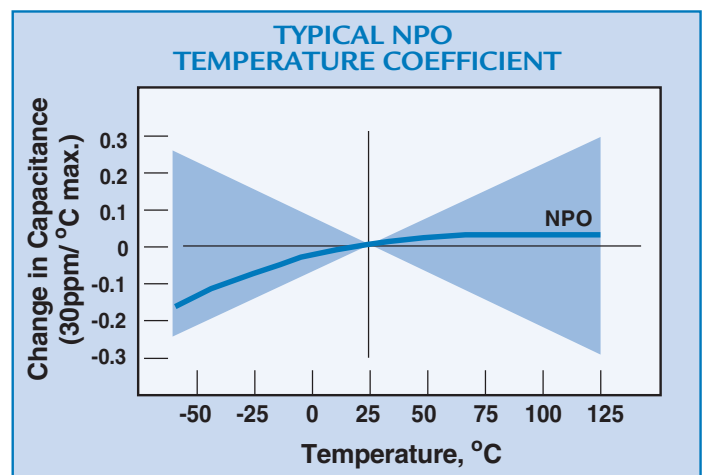
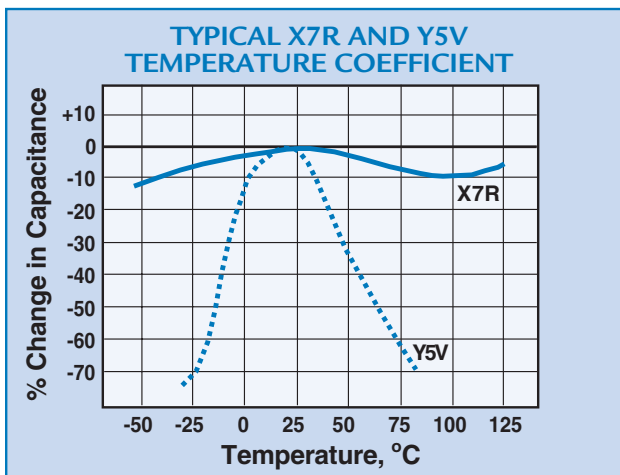

7169 Construction Court, San Diego, CA 92121 • Tel: 1+858-578-9390 • Fax: 1+858-578-6225
 www.presidiocomponents.com • email: info@presidiocomponents.com

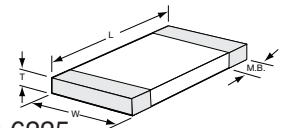

HIGH RELIABILITY "CR" CAPACITORS

SIZE	L inches (mm)	W inches (mm)	THICKNESS MAX. (T) inches (mm)	METALIZATION BAND (M.B.) inches (mm)	WVDC	DIELECTRIC		
						NPO	BX	X7R
0201	0.024 (0.61) ± 0.003 (0.08)	0.011 (0.28) ± 0.001 (0.03)	0.013 (0.33)	0.004 (0.10) min. band .008(0.20) min. space	10 V	Contact Factory	Contact Factory	0.01 µF
0402	0.040 (1.02) ± 0.004 (0.10)	0.020 (0.51) ± 0.004 (0.10)	0.024 (0.61)	0.004 (0.10) min. band 0.015 (0.38) min. space	10 V	390 pF		0.10 µF
					16 V	200 pF	2200 pF	0.010 µF
					25 V	120 pF	1500 pF	4700 pF
					50 V	100 pF	1000 pF	3900 pF
					100 V	39 pF	470 pF	1200 pF
0403	0.040 (1.02) ± 0.010 (0.25)	0.030 (0.76) ± 0.010 (0.25)	0.03 (0.76)	0.004 (0.10) min. band 0.015 (0.38) min. space	10 V	1200 pF		0.047 µF
					16 V	560 pF	3900 pF	0.022 µF
					25 V	390 pF	2700 pF	0.015 µF
					50 V	330 pF	2200 pF	0.012 µF
					100 V	68 pF	820 pF	2200 pF
0504	0.050 (1.27) ± 0.010 (0.25)	0.040 (1.02) ± 0.010 (0.25)	0.04 (1.02)	0.005 (0.13) min. band 0.015 (0.38) min. space	10 V	2700 pF		0.12 µF
					16 V	1800 pF	8200 pF	0.082 µF
					25 V	1500 pF	pF	0.047 µF
					50 V	1200 pF	4700 pF	0.039 µF
					100 V	180 pF	2200 pF	6800 pF
0603	0.063 (1.60) ± 0.006 (0.15)	0.032 (0.81) ± 0.006 (0.15)	0.035 (0.89)	0.005 (0.13) min. band 0.025 (0.64) min. space	10 V	2200 pF		0.22 µF
					16 V	1000 pF	5600 pF	0.10 µF
					25 V	680 pF	4700 pF	0.027 µF
					50 V	560 pF	3300 pF	0.022 µF
					100 V	100 pF	1200 pF	3300 pF
0805	0.080 (2.03) ± 0.010 (0.25)	0.050 (1.27) ± 0.010 (0.25)	0.055 (1.40)	0.020 (0.51) ± 0.010 (0.25)	10 V	4700 pF		1.0 µF
					16 V	3300 pF	0.027 µF	0.22 µF
					25 V	2700 pF	0.022 µF	0.10 µF
					50 V	2200 pF	0.015 µF	0.10 µF
					100 V	560 pF	6800 PF	0.022 µF
1206	0.126 (3.20) ± 0.008 (0.20)	0.063 (1.60) ± 0.008 (0.20)	0.059 (1.50)	0.020 (0.51) ± 0.010 (0.25)	10 V	0.012 µF		1.8 µF
					16 V	8200 pF	0.10 µF	0.39 µF
					25 V	6800 pF	0.082 µF	0.27 µF
					50 V	5600 pF	0.047 µF	0.22 µF
					100 V	1500 pF	0.022 µF	0.068 µF
					200 V	820 pF		0.027 µF
1209	0.125 (3.18) ± 0.010 (0.25)	0.095 (2.41) ± 0.010 (0.25)	0.065 (1.65)	0.020 (0.51) ± 0.010 (0.25)	10 V	0.018 µF		2.7 µF
					16 V	0.012 µF	0.22 µF	0.68 µF
					25 V	0.010 µF	0.18 µF	0.47 µF
					50 V	8200 pF	0.15 µF	0.39 µF
					100 V	3900 pF	0.056 µF	0.15 µF
					200 V	1800 pF		0.068 µF
1712	0.175 (4.45) ± 0.015 (0.38)	0.125 (3.18) ± 0.010 (0.25)	0.065 (1.65)	0.020 (0.51) ± 0.010 (0.25)	16 V	0.027 µF	0.47 µF	1.2 µF
					25 V	0.022 µF	0.33 µF	1.0 µF
					50 V	0.015 µF	0.22 µF	0.68 µF
					100 V	6800 pF	0.10 µF	0.27 µF
					200 V	3300 pF		0.12 µF
1812	0.180 (4.572) ± 0.015 (0.38)	0.125 (3.18) ± 0.015 (0.38)	0.080 (2.03)	0.020 (0.51) ± 0.010 (0.25)	10 V	N/A	N/A	4.7 µF
1725	0.175 (4.45) ± 0.015 (0.38)	0.250 (6.35) ± 0.018 (0.46)	0.065 (1.65)	0.020 (0.51) ± 0.010 (0.25)	16 V	0.068 µF	1.2 µF	3.3 µF
					25 V	0.056 µF	0.82 µF	2.2 µF
					50 V	0.039 µF	0.56 µF	1.8 µF
					100 V	0.018 µF	0.27 µF	0.68 µF
					200 V	8200 pF		0.27 µF
2225	0.220 (5.59) ± 0.015 (0.38)	0.250 (6.35) ± 0.018 (0.46)	0.08 (2.03)	0.020 (0.51) ± 0.010 (0.25)	16 V	0.082 µF	1.5 µF	3.9 µF
					25 V	0.068 µF	1.2 µF	3.3 µF
					50 V	0.056 µF	0.82 µF	2.2 µF
					100 V	0.027 µF	0.39 µF	1.0 µF
					200 V	0.012 µF		0.47 µF

HOW TO ORDER HIGH RELIABILITY "CR" CAPACITORS (See p. 3, Example: CR0402X7R104KENT91)

CR	0402	X7R	104	K	E	NT9	1	—
Prefix	Case Size	Dielectric Code	Capacitance Code 0.1µF	Tolerance Code ± 10%	Voltage Code 10V	Termination Code Plated SnPb over Ni	Marking & Packaging Tape & Reel, unmarked	Blank = Non-RoHS R = RoHS Compliant



HIGH RELIABILITY "SR" CAPACITORS (TESTED SIMILARLY TO MIL-PRF-123-GROUP A)

For applications that require a high level of reliability, Presidio recommends its high reliability "SR". Tested similarly to MIL-PRF-123 Group A only. Presidio manufactures this SR series on the same manufacturing line as its military products. They may be used both in military and some space applications. Please note that these capacitors are NOT MIL-qualified, nor are they the highest level of reliability for space applications. Several space level series are available. Our most popular series for space comes from the NASA drawing S311P829. Please contact factory for more info.

QUALITY ASSURANCE PROVISIONS

Every lot undergoes the following inspection and tests:

- a) **Destructive Physical Analysis (DPA)** — A representative sample is pulled from each lot and examined per relevant sections of EIA 469 and to verify adherence to Presidio's internal design criteria. Sample size is per MIL-PRF-123.
- b) **Ultrasonic Scanning (optional)** — This screening may be performed on lots to assure the highest quality microstructure. Ultrasonic scanning is not required for each lot, and must be specified on the customer purchase order.
- c) **Thermal Shock** — All parts are temperature cycled for 20 cycles in accordance with MIL-PRF-123.
- d) **Voltage Conditioning** — All parts receive a voltage conditioning at 2X rated voltage and 125°C for a minimum of 168 hours and a maximum of 264 hours. Voltage conditioning may be terminated at any time between 168 and 264 hour time intervals when failures are less than .1% or 1 piece, during the last 48 hours of the test. Tested in accordance with MIL-PRF-123 except resistors are used in place of fuses.
- e) **Insulation Resistance (IR @ 125°C)** — All parts are tested at 125°C and rated voltage in accordance with Method 302 of MIL-STD-202. The minimum IR required is 10,000 megohms or 100 megohm-microfarads.
- f) **Dielectric Withstanding Voltage (DWV)** — All parts are tested at 2.5X rated voltage in accordance with Method 301 of MIL-STD-202, or according to EIA/MIL Standards.
- g) **Insulation Resistance (IR @ 25°C)** — All parts are tested at 25°C and rated voltage in accordance with Method 302 of MIL-STD-202. The minimum IR required is 100,000 megohms or 1,000 megohm-microfarads.
- h) **Capacitance** — All parts are tested at 25°C and 1VACRMS in accordance with Method 305 of MIL-STD-202.
- i) **Dissipation Factor (DF)** — See following table:

Voltage Rating	NPO	BX/BR	X7R
10	N/A	5.0%	7.5%
16	.15%	5.0%	7.5%
25	.15%	3.5%	5.0%
50	.15%	2.5%	3.5%
> 50	.15%	2.5%	2.5%

- j) **Percent Defective Allowed (PDA)** — The cumulative PDA after voltage conditioning is 5%. Pieces rejected as out of tolerance for capacitance or visual screening will be removed from the lot but not counted in the PDA calculation.
- k) **Visual** — Performed on pieces in accordance with MIL-PRF-123 Appendix B.
- l) **Mechanical** — Level 1 AQL 1% in accordance with MIL-PRF-123.
- m) **Operating Temperature Range:** -55°C to +125°C
- n) **(Optional) Class K Element Evaluation per MIL-PRF-38534 Rev L** — Must be specified on the RFQ and Purchase Order (charge will apply). Data package included.

STANDARD PACKAGING

Product will be packaged in individual waffle trays or tape and reel as specified by customer.

DATA PACKAGE

Data will be sent with each shipment including:

- a) **Certificate of Compliance** — Certificate of Compliance and attributes test data sheet will be sent with each shipment.
- b) **(Optional) Destructive Physical Analysis Report** — Destructive Physical Analysis (DPA) report and photographs for each lot will be sent. Extra charge may apply.
- c) **(Optional) Class K Element Evaluation per MIL-PRF-38534 Rev L** — Must be specified on the RFQ and Purchase Order (charge will apply). Data package included.
- d) **(Optional) Ultrasonic Examination** — An ultrasonic scanning report will be included. Must be specified on the RFQ and Purchase Order (charge will apply).

EXAMPLE PART NUMBER
SR0402X7R104LENT91

Add "SR" to the beginning of the standard Presidio part number. See Page 3 "HOW TO ORDER A STANDARD PART"

Visit Presidio's website for additional technical information on these products.

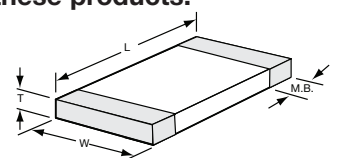

HIGH RELIABILITY "SR" CAPACITORS

SIZE	L inches (mm)	W inches (mm)	THICKNESS MAX. (T) inches (mm)	METALIZATION BAND (M.B.) inches (mm)	WVDC	DIELECTRIC		
						NPO	BX	X7R
0201	0.024 (0.61) ± 0.003 (0.08)	0.011 (0.28) ± 0.001 (0.03)	0.013 (0.33)	0.004 (0.10) min. band .008(0.20) min. space	10 V	Contact Factory	Contact Factory	0.01 µF
								0.10 µF
0402	0.040 (1.02) ± 0.004 (0.10)	0.020 (0.51) ± 0.004 (0.10)	0.024 (0.61)	0.004 (0.10) min. band 0.015 (0.38) min. space	10 V	390 pF		0.010 µF
					16 V	200 pF	1200 pF	4700 pF
					25 V	120 pF	820 pF	3900 pF
					50 V	100 pF	560 pF	3900 pF
					100 V	39 pF	330 pF	1200 pF
0403	0.040 (1.02) ± 0.010 (0.25)	0.030 (0.76) ± 0.010 (0.25)	0.03 (0.76)	0.004 (0.10) min. band 0.015 (0.38) min. space	10 V	1200 pF		0.047 µF
					16 V	560 pF	3300 pF	0.022 µF
					25 V	390 pF	2200 pF	0.015 µF
					50 V	330 pF	1500 pF	0.012 µF
					100 V	68 pF	680 pF	2200 pF
0504	0.050 (1.27) ± 0.010 (0.25)	0.040 (1.02) ± 0.010 (0.25)	0.04 (1.02)	0.005 (0.13) min. band 0.015 (0.38) min. space	10 V	2700 pF		0.12 µF
					16 V	1800 pF	6800 pF	0.082 µF
					25 V	1500 pF	5600 pF	0.047 µF
					50 V	1200 pF	3900 pF	0.039 µF
					100 V	180 pF	1800 pF	6800 pF
0603	0.063 (1.60) ± 0.006 (0.15)	0.032 (0.81) ± 0.006 (0.15)	0.035 (0.89)	0.005 (0.13) min. band 0.025 (0.64) min. space	10 V	2200 pF		0.22 µF
					16 V	1000 pF	4700 pF	0.10 µF
					25 V	680 pF	3300 pF	0.027 µF
					50 V	560 pF	2200 pF	0.022 µF
					100 V	100 pF	1000 pF	3300 pF
0805	0.080 (2.03) ± 0.010 (0.25)	0.050 (1.27) ± 0.010 (0.25)	0.055 (1.40)	0.020 (0.51) ± 0.010 (0.25)	10 V	4700 pF		1.0 µF
					16 V	3300 pF	0.022 µF	0.22 µF
					25 V	2700 pF	0.018 µF	0.10 µF
					50 V	2200 pF	0.010 µF	0.10 µF
					100 V	560 pF	5600 pF	0.022 µF
1206	0.126 (3.20) ± 0.008 (0.20)	0.063 (1.60) ± 0.008 (0.20)	0.059 (1.50)	0.020 (0.51) ± 0.010 (0.25)	10 V	0.012 µF		1.8 µF
					16 V	8200 pF	0.082 µF	0.39 µF
					25 V	6800 pF	0.056 µF	0.27 µF
					50 V	5600 pF	0.039 µF	0.22 µF
					100 V	1500 pF	0.022 µF	0.068 µF
					200 V	820 pF		0.027 µF
1209	0.125 (3.18) ± 0.010 (0.25)	0.095 (2.41) ± 0.010 (0.25)	0.065 (1.65)	0.020 (0.51) ± 0.010 (0.25)	10 V	0.018 µF		2.7 µF
					16 V	0.012 µF	0.22 µF	0.68 µF
					25 V	0.010 µF	0.18 µF	0.47 µF
					50 V	8200 pF	0.12 µF	0.39 µF
					100 V	3900 pF	0.047 µF	0.15 µF
					200 V	1800 pF		0.068 µF
1712	0.175 (4.45) ± 0.015 (0.38)	0.125 (3.18) ± 0.010 (0.25)	0.065 (1.65)	0.020 (0.51) ± 0.010 (0.25)	16 V	0.027 µF	0.33 µF	1.2 µF
					25 V	0.022 µF	0.22 µF	1.0 µF
					50 V	0.015 µF	0.18 µF	0.68 µF
					100 V	6800 pF	0.068 µF	0.27 µF
					200 V	3300 pF		0.12 µF
1812	0.180 (4.572) ± 0.015 (0.38)	0.125 (3.18) ± 0.015 (0.38)	0.080 (2.03)	0.020 (0.51) ± 0.010 (0.25)	10 V	N/A	N/A	4.7 µF
1725	0.175 (4.45) ± 0.015 (0.38)	0.250 (6.35) ± 0.018 (0.46)	0.065 (1.65)	0.020 (0.51) ± 0.010 (0.25)	16 V	0.068 µF	0.82 µF	3.3 µF
					25 V	0.056 µF	0.56 µF	2.2 µF
					50 V	0.039 µF	0.47 µF	1.8 µF
					100 V	0.018 µF	0.22 µF	0.68 µF
					200 V	8200 pF		0.27 µF
2225	0.220 (5.59) ± 0.015 (0.38)	0.250 (6.35) ± 0.018 (0.46)	0.08 (2.03)	0.020 (0.51) ± 0.010 (0.25)	16 V	0.082 µF	1.2 µF	3.9 µF
					25 V	0.068 µF	1.0 µF	3.3 µF
					50 V	0.056 µF	0.68 µF	2.2 µF
					100 V	0.027 µF	0.33 µF	1.0 µF
					200 V	0.012 µF		0.47 µF

Note: Above parts are tested similarly to MIL-PRF-123 Group A only. (Ultrasonic exam not included; can be ordered as an option.)
 Presidio has the ability to add Group B for space applications. Call the factory for more information.

HOW TO ORDER HIGH RELIABILITY "SR" CAPACITORS (See p. 3, Example: SR0402X7R104LENT91)

SR	0402	X7R	104	L	E	NT9	1	—
Prefix	Case Size	Dielectric Code	Capacitance Code 0.1 µF	Tolerance Code -10% / +20%	Voltage Code 10 V	Termination Code Ni/SnPb	Marking & Packaging Reel, unmarked	Blank = Non-RoHS R = RoHS Compliant



SPACE SERIES SR#M123A SERIES SURFACE MOUNT CERAMIC CHIP CAPACITORS

FORMERLY “#M123 DRAWING”

For space flight applications that require the highest level of reliability, Presidio recommends its high reliability extended range chip capacitors. Tested to the requirements of MIL-PRF-123, Presidio manufactures these chips on the same manufacturing line as its military products. Please note these capacitors are NOT MIL-qualified. Most parts from the SR#M123A series do not meet the MIL-PRF-123 design requirements for dielectric thickness. All parts are manufactured with **PRECIOUS METAL ELECTRODES**.

NASA S311P829 SPECIFICATION
 Most of these chips are available per this most popular NASA drawing. Please click on the NASA S311P829 link on Presidio's website:
<https://presidiocomponents.com>

QUALITY ASSURANCE PROVISIONS

Every lot undergoes the following inspection and tests.

DESTRUCTIVE PHYSICAL ANALYSIS (DPA) — A representative sample is pulled from each lot and examined per EIA RS469 and to verify adherence to Presidio's design criteria. Sample size is per MIL-PRF-123.

ULTRASONIC INSPECTION —

Code A: Ultrasonic inspection is performed on 100% of the parts, except for Case Code 0201 where real time X-Ray is used instead.

THERMAL SHOCK — All parts are temperature cycled for 20 cycles to MIL-STD-202 Method 107, Condition A, except that max temperature is 125°C.

VOLTAGE CONDITIONING — All parts receive a voltage conditioning at 2X rated voltage and 125°C for a minimum of 168 hours and a maximum of 264 hours. Voltage Conditioning may be terminated at any time between 168 and 264 hour time interval that failures are less than .1% or 1 piece during the last 48 hours of the test. Method follows MIL-PRF-123. Resistors, instead of fuses are acceptable.

INSULATION RESISTANCE (IR @ 125°C) — All parts are tested at 125°C and Rated Voltage in accordance with Method 302 of MIL-STD-202. The minimum IR required is 10,000 Megohms or 100 Megohm-Microfarads.

DIELECTRIC WITHSTANDING VOLTAGE (DWV) — All parts are tested at 2.5X rated voltage in accordance with Method 301 of MIL-STD-202.

INSULATION RESISTANCE (IR @ 25°C) — All parts are tested at 25°C and Rated Voltage in accordance with Method 302 of MIL-STD-202. The minimum IR required is 100,000 Megohms or 1,000 Megohm-Microfarads.

CAPACITANCE — All parts are tested at 25°C and 1VACRMS in accordance with Method 305 of MIL-STD-202.

DISSIPATION FACTOR (DF) — See following table:

VOLTAGE RATING	NPO	X7R
Below 16V	N/A	7.5%
16V	0.15%	5%
25V	0.15%	4%
50V	0.15%	3.5%
100V+	0.15%	2.5%

* For 10V rating or lower, see note 1/ on page 3

PERCENT DEFECTIVE ALLOWED (PDA) — The cumulative PDA after Voltage Conditioning is 5%. Pieces rejected as out of tolerance for capacitance or visual screening will be removed from the lot but not counted in the PDA calculation.

VISUAL — A 100% inspection is performed IAW MIL-PRF-123 Appendix B.

MECHANICAL — Level 1 AQL 1% in accordance with MIL-PRF-123.

• **THERMAL SHOCK AND LIFE TEST** — A sample is pulled from each lot. 100 Thermal shock cycles are performed and Life Test is performed for 1000 hours at 2X rated voltage and 125°C. Sample size and method follows MIL-PRF-123.

• **HUMIDITY, STEADY STATE, LOW VOLTAGE** — A sample of 12 pieces is pulled from each lot and tested per MIL-PRF-123.

MARKING (Optional for sizes 0805 and larger only) — Parts will not be marked unless marking is specified on the PO. If marking is specified, a color letter will be used per Presidio's chip marking system.

STANDARD PACKAGING

Product will be packaged in individual waffle trays. Tape and reel option is available.

DATA PACKAGE

Data will be sent with each shipment including:

- CERTIFICATE of COMPLIANCE
- DPA REPORT
- GROUP A & B ATTRIBUTE DATA SHEET
- LIFE TEST AND HUMIDITY VARIABLES DATA SHEET.

Group B required for flight parts. Parts for engineering models may be subject to lesser screening requirements.

PART NUMBER EXAMPLE
SR0402X7R104KENT91(D)#M123A
 PART DESCRIPTION: SR, 0402, X7R, 0.1µF, ±10%, 10V, Plated SnPb Over Ni Termination, Tape & Reel, Design-In Code (D) for Arizona, Screened Similar to MIL-PRF-123 Group A and Group B with 100% Ultrasonic Inspection.

C OF C AND DATA PACK INCLUDED WITH THE PARTS.

EXAMPLE: SR0402X7R104KENT91(D)#M123A

HOW TO ORDER

See Website for Design-In Codes

SR	0402	X7R	104	K	E	NT9	1	(D)	#M123	A
Prefix	Size	Dielectric	Capacitance Code	Tolerance Code	Voltage Code	Termination Code	Packaging Code	Design-In Code	Suffix	Ultrasonic Inspection
SR	See Page 3 (Other Sizes Available)	X7R NPO (Other Dielectrics Available)	Two significant figures followed by the number of zeros. Example: R05 = 0.05pF 0R1 = 0.1 pF 1R0 = 1.0 pF 100 = 10 pF 101 = 100 pF 102 = 1000 pF 103 = .01 µF 104 = .10 µF 105 = 1.0 µF	A = ±.05pF < 10pF B = ±.10pF < 10pF C = ±.25pF < 10pF D = ±.50pF < 10pF E = ±0.5% ≥ 10pF F = ±1% ≥ 10pF G = ±2% ≥ 10pF J = ±5% ≥ 10pF K = ±10% L = -10% / +20% M = ±20%	B = 5 VDC E = 10 VDC F = 12 VDC G = 16 VDC 1 = 25 VDC 2 = 50 VDC 3 = 100 VDC 4 = 200 VDC Other Voltages Available Examples: 63, 75, 150, 250 VDC, etc.	NT9 = Plated SnPb over Ni Min 4% Pb P = PdAg (Thick Film) H = 100% Au (Thick Film) NG* = Plated Au over Ni P & H are non-magnetic * for legacy parts	1 = Reel, 7", plastic tape, unmarked 2 = Reel, 7", plastic tape, marked 5 = Waffle, unmarked 6 = Waffle, marked	See Back Page (Optional)	#M123	A = 100%

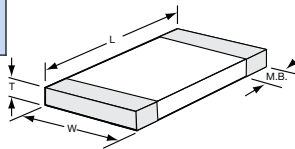

DATA SHEET FOR SR#M123A SERIES

FOR SPACE APPLICATIONS

SIZE	L inches (mm)	W inches (mm)	THICKNESS MAX (T) inches (mm)	METALIZATION BAND (M.B.) inches (mm)	VVDC	DIELECTRIC (Maximum Capacitance)		Available as S-311
						NPO	X7R	
0201	0.024 (0.61) ± 0.003 (0.08)	0.011 (0.28) ± 0.001 (0.03)	0.013 (0.33)	.004 (0.10) min. band .008 (0.20) min. space	10 V	Consult Factory	0.01 µF 1/	No
					16 V	390 pF	0.10 µF 1/	No
0402	0.040 (1.02) ± 0.006 (0.15)	0.020 (0.51) ± 0.004 (0.10)	0.024 (0.61)	.004 (0.10) min. band .015 (0.38) min. space	16 V	200 pF	0.01 µF	No
					25 V	120 pF	4700 pF	Yes
					50 V	100 pF	3900 pF	Yes
					100 V	39 pF	1200 pF	Yes
					10 V	1200 pF	0.022 µF	No
0403	0.040 (1.02) ± 0.010 (0.25)	0.030 (0.76) ± 0.010 (0.25)	0.030 (0.76)	.004 (0.10) min. band .015 (0.38) min. space	16 V	560 pF	0.022 µF	No
					25 V	390 pF	0.015 µF	Yes
					50 V	330 pF	0.012 µF	Yes
					100 V	68 pF	2200 pF	Yes
					10 V	2700 pF	0.082 µF	No
0504	0.050 (1.27) ± 0.010 (0.25)	0.040 (1.02) ± 0.010 (0.25)	0.040 (1.02)	.005 (0.13) min. band .015 (0.38) min. space	16 V	1800 pF	0.082 µF	No
					25 V	1500 pF	0.047 µF	Yes
					50 V	1200 pF	0.039 µF	Yes
					100 V	180 pF	6800 pF	Yes
					10 V	2200 pF	0.22 µF	No
Low Inductance 0306	0.032 (0.81) ± 0.006 (0.15)	0.063 (1.60) ± 0.006 (0.15)	0.033 (0.84) See Note 2/	.005 (0.13) min. band .010 (0.25) min. space	5 V	N/A	0.10 µF	Yes
					16 V		0.10 µF	Yes
					25 V		0.022 µF	Yes
0603	0.063 (1.60) ± 0.006 (0.15)	0.032 (0.81) ± 0.006 (0.15)	0.035 (0.89)	.005 (0.13) min. band .025 (0.64) min. space	10 V	2200 pF	0.22 µF	No
					16 V	1000 pF	0.10 µF	No
					25 V	680 pF	0.027 µF	Yes
					50 V	560 pF	0.022 µF	Yes
					100 V	100 pF	3300 pF	Yes
Low Inductance 0508	0.050 (1.27) ± 0.010 (0.25)	0.080 (2.03) ± 0.010 (0.25)	0.045 (1.14) See Note 3/	.005 (0.13) min. band .020 (0.51) min. space	10 V	N/A	0.12 µF	Yes
					16 V		0.10 µF	Yes
					25 V		0.047 µF	Yes
0805	0.080 (2.03) ± 0.010 (0.25)	0.050 (1.27) ± 0.010 (0.25)	0.055 (1.40)	0.020 (0.51) ± 0.010 (0.25)	10 V	4700 pF	1.0 µF 1/	No
					16 V	3300 pF	0.22 µF	No
					25 V	2700 pF	0.10 µF	Yes
					50 V	2200 pF	0.10 µF	Yes
					100 V	560 pF	0.022 µF	Yes
Low Inductance 0612	0.063 (1.60) ± 0.010 (0.25)	0.126 (3.20) ± 0.010 (0.25)	0.055 (1.40)	.005 (0.13) min. band .025 (0.64) min. space	16 V	N/A	0.27 µF	Yes
					25 V		0.22 µF	Yes
1206	0.126 (3.20) ± 0.008 (0.20)	0.063 (1.60) ± 0.008 (0.20)	0.060 (1.52)	0.020 (0.51) ± 0.010 (0.25)	10 V	0.012 µF	1.8 µF 1/	No
					16 V	8200 pF	0.39 µF	No
					25 V	6800 pF	0.27 µF	Yes
					50 V	5600 pF	0.22 µF	Yes
					100 V	1500 pF	0.10 µF	Yes
1209	0.125 (3.18) ± 0.010 (0.25)	0.095 (2.41) ± 0.010 (0.25)	0.065 (1.65)	0.020 (0.51) ± 0.010 (0.25)	10 V	0.018 µF	2.7 µF 1/	No
					16 V	0.012 µF	0.68 µF	No
					25 V	0.010 µF	0.47 µF	Yes
					50 V	8200 pF	0.39 µF	Yes
					100 V	3900 pF	0.15 µF	Yes
Low Inductance 0912	0.095 (2.41) ± 0.010 (0.25)	0.126 (3.20) ± 0.010 (0.25)	0.065 (1.65)	.005 (0.13) min. band .025 (0.64) min. space	16 V	N/A	0.68 µF	Yes
					25 V		0.47 µF	Yes
1712	0.175 (4.45) ± 0.015 (0.38)	0.125 (3.18) ± 0.010 (0.25)	0.065 (1.65)	0.020 (0.51) ± 0.010 (0.25)	16 V	0.027 µF	1.2 µF	No
					25 V	0.022 µF	1.0 µF	Yes
					50 V	0.015 µF	0.68 µF	Yes
					100 V	6800 pF	0.27 µF	Yes
1812	0.180 (4.572) ± 0.015 (0.38)	0.125 (3.18) ± 0.015 (0.38)	0.080 (2.03)	0.020 (0.51) ± 0.010 (0.25)	10 V	N/A	4.7 µF 1/	Yes
1725	0.180 (4.45) ± 0.015 (0.38)	0.250 (6.35) ± 0.018 (0.46)	0.065 (1.65) *0.080 (2.03) For max cap value	0.020 (0.51) ± 0.010 (0.25)	16 V	0.068 µF	3.3 µF	No
					25 V	0.056 µF	2.2 µF	Yes
					50 V	0.039 µF	2.2 µF	No
					100 V	0.018 µF	0.68 µF	Yes
2225	0.220 (5.59) ± 0.015 (0.38)	0.250 (6.35) ± 0.018 (0.46)	0.080 (2.03)	0.020 (0.51) ± 0.010 (0.25)	16 V	0.082 µF	3.9 µF	No
					25 V	0.068 µF	3.3 µF	Yes
					50 V	0.056 µF	2.2 µF	Yes
					100 V	0.027 µF	1.0 µF	Yes

1/ The capacitance values in this category may have DF readings up to 7.5%. 2/ Also available as 0.024 Max Thickness 3/ Also available as 0.020 Max Thickness

SR#N1, HR#N2, HR#N3 SERIES FOLLOWING EEE-INST-002 LEVEL 1, 2, and 3

QUALITY ASSURANCE PROVISIONS

Every lot undergoes the following inspection and tests.

GROUP 1

1. Thermal shock before Voltage conditioning, (SR#N1, HR#N2,): MIL-STD-202 Method 107 Condition B (-55/+125°C).
2. Voltage Conditioning at 125°C, SR#N1: 160Hrs, HR#N2: 96Hrs, HR#N3: 48Hrs. Vtest = 2X rated for ≤ 500V, 1.2X rated for 501 to 999V, 1X rated ≥ 1000V.
3. Capacitance (SR#N1, HR#N2, HR#N3): all parts are tested at 25°C and 1 VACRMS in accordance with Method 305 of MIL-STD-202.
4. Dissipation Factor, DF, (SR#N1, HR#N2, HR#N3): Capacitance: all parts are tested at 25°C and 1 VACRMS in accordance with Method 305 of MIL-STD-202
5. Dielectric Withstanding Voltage, DWM, (SR#N1, HR#N2, HR#N3): MIL-STD-202 Method 301. Test is performed at 2.5X rated voltage for rating below 500V.
6. Insulation Resistance 1, (SR#N1, HR#N2, HR#N3): MIL-STD-202 Method 301, room temperature.
7. Insulation Resistance 2, (SR#N1): MIL-STD-202 Method 301, repeat at max. rated temp. (125°C).
8. Percentage Defective Allowed (PDA): SR#N1: 5%, HR#N2: 10%, HR#N3: 20%.
9. Radiographic inspection: For SR#N1 leaded parts only, not applicable for SMD Chips.
10. Visual and Mechanical Examination (SR#N1, HR#N2).

GROUP 2

- Voltage/Temperature Limit (SR#N1–12(1) pcs, HR#N2 – 6(1) pcs), Not applicable to X7R.
- Temperature Coefficient and Drift (SR#N1- HR#N2), N/A for BX/BR/BQ/BZ/X7R parts.

GROUP 3

- Terminal Strength: N/A for surface mount chips.
- Resistance to Solder Heat (SR#N1, HR#N2): MIL-STD-202, Method 210 Condition C (chips). Condition G (Leaded).
- Moisture Resistance (SR#N1–12(0), HR#N2 – 6(0)): MIL-STD-202, Method 106. Exception: For size ≤ 0603 test is performed on larger size parts cut from the same wafer. Test voltage is rated voltage or 50V whichever is less.

GROUP 4

- Humidity Steady State Low Voltage (SR#N1–12(0) pcs, HR#N2–5(0) pcs), MIL-STD-202 Method 103 Condition A and MIL-PRF-123 Group B

GROUP 5

- Solderability (SR#N1–5(0) pcs, HR#N2–3(0) pcs): MIL-STD-202, Method 208
- Destructive Physical Analysis: (SR#N1): EIA-469 Exception: Use separate pieces for Solderability Test 5(0) and DPA.

GROUP 6

- Life (at elevated temperature: 125°C), (SR#N1–2000H, 22(0) pcs, HR#N2–1000H, 22(1)) pcs): Vtest = 2X rated for ≤ 500V, 1.2X rated for 501 to 999V, 1X rated ≥ 1000V
- Partial Discharge aka Corona Test for SR#N1 and HR#N2 for voltage rating ≥ 1000V

MARKING (Optional for sizes 0805 and larger only) – Parts will not be marked unless marking is specified on the PO. If marking is specified, a color letter will be used per Presidio's chip marking system.

STANDARD PACKAGING

Product will be packaged in individual waffle trays. Tape and reel option is available.

DATA PACKAGE

Level/Series	Level 1 Series SR#N1	Level 2 Series HR#N2	Level 3 Series HR#N3
Certificate of Conformity	YES	YES	YES
DPA Report	YES	NO	NO
Group 1 to 6 Data when Applicable	YES	YES	NO

PART NUMBER EXAMPLE

HR0402X7R104KENT91(D)#N2

PART DESCRIPTION: HR, 0402, X7R, 0.12µF, ±10%, 10V, Plated SnPb Over Ni Termination, Tape & Reel, Design-In Code (D) for Arizona, Screened following EEE-INST-002 Level 2.

C OF C AND DATA PACK INCLUDED WITH THE PARTS.

HOW TO ORDER

See Website for Design-In Codes

EXAMPLE: HR0402X7R104KENT91(D)#N2

HR	0402	X7R	104	K	E	NT9	1	(D)	#N2
Prefix	Size	Dielectric	Capacitance Code	Tolerance Code	Voltage Code	Termination Code	Packaging Code	Design-In Code	Suffix
SR* HR	See Page 3 (Other Sizes Available)	X7R NPO (Other Dielectrics Available)	Two significant figures followed by the number of zeros. Example: R05 = 0.05pF 0R1 = 0.1 pF 1R0 = 1.0 pF 100 = 10 pF 101 = 100 pF 102 = 1000 pF 103 = .01 µF 104 = .10 µF 105 = 1.0 µF	A = ± .05pF < 10pF B = ± .10pF < 10pF C = ± .25pF < 10pF D = ± .50pF < 10pF E = ± 0.5% ≥ 10pF F = ± 1% ≥ 10pF G = ± 2% ≥ 10pF J = ± 5% ≥ 10pF K = ± 10% L = -10% / +20% M = ± 20%	B = 5 VDC E = 10 VDC F = 12 VDC G = 16 VDC 1 = 25 VDC 2 = 50 VDC 3 = 100 VDC 4 = 200 VDC Other Voltages Available Examples: 63, 75, 150, 250 VDC, etc.	NT9 = Plated SnPb over Ni Min 4% Pb P = PdAg (Thick Film) H = 100% Au (Thick Film) NG* = Plated Au over Ni P & H are non-magnetic * for legacy parts	1 = Reel, 7", plastic tape, unmarked 2 = Reel, 7", plastic tape, marked 5 = Waffle, unmarked 6 = Waffle, marked	See Back Page (Optional)	N1* N2 N3

*SR prefix is used with #N1 suffix only.

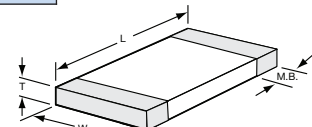

PRESIDIO COMPONENTS, INC.

7169 Construction Court, San Diego, CA 92121 • Tel: 1+858-578-9390 • Fax: 1+858-578-6225

www.presidiocomponents.com • email: info@presidiocomponents.com



PRESIDIO COMPONENTS, INC.

Manufacturer of High-Rel Ceramic Capacitors Since 1980

MILITARY & SPACE QUALIFICATIONS

NASA SPEC	DESCRIPTION
S311-P-829 Most Popular chip series for space, many parts within 4 weeks	SMD Chips 0402 to 2225 – 5V to 100V – TOR Compliant (0402 - 0.1µF - 10V), (0805 - 1µF - 10V), (1812 - 4.7µF - 10V) Includes reverse geometry for low inductance chips Toughest standard screening available
MIL SPECS	DESCRIPTION
MIL-PRF-55681-‘S’ Level	SMD 0805 TO 2225 – 50V and 100V CDR01, CDR02, CDR03, CDR04, CDR05, CDR06, CDR31, CDR32, CDR33, CDR34, CDR35 CDR 11 & 12 (0505) – CDR 13 & 14 (1010) 50V to 500V
MIL-PRF-123	SMD Chips 0805 to 2225 – 50V and 100V – TOR Compliant CKS51, CKS52, CKS53, CKS54, CKS55, CKS56, CKS57
MIL-PRF-32535	SMD Chips 0201 to 2220 – 4V to 200V – Qualified 0201 0.01µF, 0402 0.1µF up to 0805
MIL-PRF-49467	Radial Lead up to 5000V – TOR Compliant
MIL-PRF-49470	SMPS Ceramic Stack 25V to 500V – TOR Compliant

DLA DRAWINGS	DESCRIPTION	DLA DRAWINGS	DESCRIPTION
06019 06022	0505 and 1010 RF for Space: Equivalent to CDR 11, 12, 13 & 14 but with a higher screening level	87046	Radial Leads NPO - 1000V
03028	SMD - 0603	87114	Radial Leads NPO - 3000V
03029	SMD - 0402	87076	Radial Leads NPO - 4000V
05001	SMD - 0805 RF	87077	Radial Leads NPO - 5000V
05002	SMD - 0603 RF	87043	Radial Leads X7R - 1000V
05003	SMD - 0402 RF	87040	Radial Leads X7R - 2000V
05006	SMD - 0805 - Extended Range	87047	Radial Leads X7R - 3000V
05007	SMD - 1206 - Extended Range	89044	Radial Leads X7R - 4000V
91019	SMD - 2220 - 25V and 50V	87070	Radial Leads X7R - 5000V
14004	SMD - 0306 - Thin Low Inductance Chips	87081	Radial Leads X7R - 10,000V
14005	SMD - 0508 - Thin Low Inductance Chips	88011	SMPS Stack NPO - 25V to 500V

QUALITY SYSTEM	DESCRIPTION
MIL-STD-790G	Established Reliability and High Reliability Qualified Products List (QPL) Systems for Electronic Parts Specifications

HIGH VOLTAGE CERAMIC CAPACITORS

For use in high reliability high voltage applications, Presidio recommends its high voltage capacitors. Available screened to the requirements of MIL-PRF-49467, the high voltage parts may require encapsulation to prevent surface breakdown.

SIZE	L inches (mm)	W inches (mm)	THICKNESS MAX (T) inches (mm)	METALIZATION BAND inches (mm)	WVDC	DIELECTRIC	
						NPO	X7R
1209	0.125 (3.18) ± 0.010 (0.25)	0.095 (2.41) ± 0.010 (0.25)	0.080 (2.03)	0.020 (0.51) ± 0.010 (0.25)	500 V	2700 pF	0.022 µF
					1000 V	390 pF	1800 pF
1514	0.150 (3.81) ± 0.010 (0.25)	0.140 (3.56) ± 0.010 (0.25)	0.140 (3.56)	0.020 (0.51) ± 0.010 (0.25)	500 V	3900 pF	0.039 µF
					1000 V	1800 pF	0.01 µF
					2000 V	390 pF	1800 pF
					3000 V	150 pF	820 pF
1712	0.175 (4.46) ± 0.015 (0.38)	0.125 (3.18) ± 0.010 (0.25)	0.120 (3.05)	0.020 (0.51) ± 0.010 (0.25)	500 V	6800 pF	0.068 µF
					1000 V	2200 pF	0.015 µF
					2000 V	270 pF	1800 pF
1812	0.180 (4.57) ± 0.020 (0.51)	0.125 (3.18) ± 0.010 (0.25)	0.120 (3.05)	0.020 (0.51) ± 0.010 (0.25)	500 V	6800 pF	0.068 µF
					1000 V	2200 pF	0.015 µF
					2000 V	270 pF	1800 pF
1825	0.180 (4.57) ± 0.020 (0.51)	0.250 (6.35) max.	0.160 (4.06)	0.020 (0.51) ± 0.010 (0.25)	500 V	0.012 µF	0.15 µF
					1000 V	5600 pF	0.027 µF
					2000 V	1000 pF	6800 pF
					3000 V	470 pF	1800 pF
1918	0.190 (4.83) ± 0.013 (0.33)	0.180 (4.57) ± 0.013 (0.33)	0.150 (3.81)	0.020 (0.51) ± 0.010 (0.25)	500 V	8200 pF	0.082 µF
					1000 V	3900 pF	0.022 µF
					2000 V	820 pF	4700 pF
					3000 V	330 pF	1800 pF
2225	0.230 (5.84) ± 0.020 (0.51)	0.250 (6.35) ± 0.018 (0.46)	0.200 (5.08)	0.020 (0.51) ± 0.010 (0.25)	500 V	0.015 µF	0.39 µF
					1000 V	6800 pF	0.068 µF
					2000 V	1500 pF	0.012 µF
					3000 V	560 pF	3900 pF

HOW TO ORDER HIGH VOLTAGE CAPACITORS (See p. 3, Example: HR1825X7R102K11P1R)

HR	1825	X7R	102	K	11	P	1	R
Prefix HR, CR, SR Leave blank for Industrial	Case Size	Dielectric Code	Capacitance Code 1000 pF	Tolerance Code ± 10%	Voltage Code 2000 V	Termination Code PdAg	Marking & Packaging Reel, unmarked	Blank = Non-RoHS R = RoHS Compliant

If you are looking for High Voltage Radial Leaded QPL part numbers per MIL-PRF-49467, please consult our High Voltage Ceramic Capacitors Catalog.

For non QPL case sizes and voltages for Radial Leaded Ceramic Capacitors, we offer the following Hi-Rel Space screening:

- HR#49467A Series — Screening and testing similar to MIL-PRF-49467 Group A only
- HR#49467AB Series — Screening and testing similar to MIL-PRF-49467 Group A and Group B
- Data Package included with the parts



7169 Construction Court, San Diego, CA 92121 • Tel: 1+858-578-9390 • Fax: 1+858-578-6225
www.presidiocomponents.com • email: info@presidiocomponents.com

HIGH VOLTAGE CERAMIC CAPACITORS (continued)

For case sizes larger than 2225 we recommend adding a lead frame to the chip to better absorb any thermo-mechanical stress. Radial Lead, Surface Mount or Through Hole styles are available.

SIZE	L inches (mm)	W inches (mm)	THICKNESS MAX inches (mm)	METALIZATION BAND inches (mm)	WVDC	DIELECTRIC	
						NPO	X7R
2720	0.270 (6.85) ± 0.020 (0.51)	0.230 (5.84) max.	0.200 (5.08)	0.020 (0.51) ± 0.010 (0.25)	500 V	0.012 µF	0.1 µF
					1000 V	5600 pF	0.027 µF
					2000 V	1500 pF	6800 pF
					3000 V	560 pF	3300 pF
2824	0.280 (7.11) ± 0.020 (0.51)	0.250 (6.35) max.	0.150 (3.81)	0.020 (0.51) ± 0.010 (0.25)	500 V	0.022 µF	0.22 µF
					1000 V	8200 pF	0.047 µF
					2000 V	1800 pF	0.01 µF
					3000 V	820 pF	3300 pF
3012	0.300 (7.62) ± 0.020 (0.51)	0.150 (3.81) max.	0.150 (3.81)	0.020 (0.51) ± 0.010 (0.25)	500 V	0.012 µF	0.082 µF
					1000 V	5600 pF	0.018 µF
					2000 V	560 pF	3300 pF
					3000 V	390 pF	1200 pF
3728	0.370 (9.40) ± 0.020 (0.51)	0.330 (8.38) max.	0.220 (5.59)	0.020 (0.51) ± 0.010 (0.25)	500 V	0.033 µF	0.27 µF
					1000 V	0.018 µF	0.082 µF
					2000 V	2700 pF	0.015 µF
					3000 V	1800 pF	5600 pF
					4000 V	680 pF	3300 pF
3933	0.380 (9.65) ± 0.020 (0.51)	0.350 (8.89) max.	0.150 (3.81)	0.020 (0.51) ± 0.010 (0.25)	500 V	0.047 µF	0.47 µF
					1000 V	0.018 µF	0.1 µF
					2000 V	3900 pF	0.022 µF
					3000 V	1800 pF	8200 pF
					4000 V	1000 pF	3900 pF
4018	0.400 (10.16) ± 0.020 (0.51)	0.210 (5.33) max.	0.200 (5.08)	0.020 (0.51) ± 0.010 (0.25)	500 V	0.022 µF	0.15 µF
					1000 V	0.012 µF	0.047 µF
					2000 V	1200 pF	0.01 µF
					3000 V	820 pF	3900 pF
					4000 V	560 pF	2200 pF
4040	0.400 (10.16) ± 0.028 (0.71)	0.400 (10.16) ± 0.028 (0.71)	0.150 (3.81)	0.020 (0.51) ± 0.010 (0.25)	500 V	0.047 µF	0.47 µF
					1000 V	0.022 µF	0.12 µF
					2000 V	5600 pF	0.027 µF
					3000 V	2200 pF	0.012 µF
					4000 V	1000 pF	5600 pF
					5000 V	680 pF	3900 pF
4540	0.450 (11.43) ± 0.032 (0.81)	0.400 (10.16) ± 0.028 (0.71)	0.150 (3.81)	0.020 (0.51) ± 0.010 (0.25)	500 V	0.068 µF	0.68 µF
					1000 V	0.027 µF	0.15 µF
					2000 V	6800 pF	0.039 µF
					3000 V	2700 pF	0.015 µF
					4000 V	1200 pF	6800 pF
					5000 V	820 pF	4700 pF
4838	0.470 (11.94) ± 0.020 (0.51)	0.430 (10.92) max.	0.220 (5.59)	0.020 (0.51) ± 0.010 (0.25)	500 V	0.056 µF	0.47 µF
					1000 V	0.033 µF	0.15 µF
					2000 V	5600 pF	0.027 µF
					3000 V	3900 pF	0.012 µF
					4000 V	1000 pF	4700 pF
					5000 V	820 pF	3300 pF
5848	0.570 (14.48) ± 0.020 (0.51)	0.530 (13.46) max.	0.220 (5.59)	0.020 (0.51) ± 0.010 (0.25)	500 V	0.1 µF	0.68 µF
					1000 V	0.047 µF	0.22 µF
					2000 V	0.01 µF	0.047 µF
					3000 V	6800 pF	0.022 µF
					4000 V	1800 pF	8200 pF
					5000 V	1500 pF	4700 pF
6860	0.670 (17.02) ± 0.020 (0.51)	0.650 (16.51) max.	0.220 (5.59)	0.020 (0.51) ± 0.010 (0.25)	500 V	0.15 µF	1.0 µF
					1000 V	0.068 µF	0.33 µF
					2000 V	0.015 µF	0.068 µF
					3000 V	0.01 µF	0.033 µF
					4000 V	2700 pF	0.012 µF
					5000 V	2200 pF	8200 pF

Other sizes available.



PRESIDIO COMPONENTS, INC.

7169 Construction Court, San Diego, CA 92121 • Tel: 1+858-578-9390 • Fax: 1+858-578-6225

www.presidiocomponents.com • email: info@presidiocomponents.com

LOW INDUCTANCE CAPACITORS

In high speed switching applications where the inductance of a traditional form factor impairs the performance of the circuit, Presidio recommends its low inductance capacitors.

SIZE	L inches (mm)	W inches (mm)	THICKNESS MAX. (T) inches (mm)	METALIZATION BAND (M.B.) inches (mm)	WVDC	DIELECTRIC	
						X7R	
0306	0.032 (0.81) ± 0.008 (0.20)	0.063 (1.60) ± 0.008 (0.20)	0.033 (0.84)	0.005 (0.13) min. band 0.010 (0.25) min. space	16 V	0.10 µF	NO
					25 V	0.022 µF	YES
0508	0.050 (1.27) ± 0.010 (0.25)	0.080 (2.03) ± 0.010 (0.25)	0.045 (1.14)	0.005 (0.13) min. band 0.020 (0.51) min. space	6.3 V	0.18 µF	NO
					10 V	0.12 µF	NO
					16 V	0.10 µF	NO
					25 V	0.047 µF	YES
0612	0.063 (1.60) ± 0.010 (0.25)	0.126 (3.20)± 0.010 (0.25)	0.055(1.40)	0.005 (0.13) min. band 0.025 (0.64) min. space	16 V	0.27 µF	NO
					25 V	0.22 µF	YES
0912	0.095 (2.41) ± 0.010 (0.25)	0.126 (3.20) ± 0.010 (0.25)	0.065 (1.65)	0.005 (0.13) min. band 0.025 (0.64) min. space	16 V	0.68 µF	NO
					25 V	0.47 µF	YES
MIL-PRF-123 MINIMUM DIELECTRIC THICKNESS COMPLIANT:						0.8 mils for 50V 1.0 mils for 100V	YES/NO

HOW TO ORDER LOW INDUCTANCE CAPACITORS (See p. 3, Example: SR0306X7R224LENT91)

SR	0306	X7R	224	L	E	NT9	1	—
Prefix	Case Size	Dielectric Code	Capacitance Code .022 µF	Tolerance Code -10% / +20%	Voltage Code 10V	Termination Code Ni/SnPb	Marking and Packaging Reel, unmarked	Blank = Non-RoHS R = RoHS Compliant

OTHER AVAILABLE SIZES

Chart below shows additional sizes available from factory

SIZE	L inches (mm)	W inches (mm)	Thickness Max. (T) inches (mm)	DIELECTRIC							
				NPO		BX		X7R		Y5V	
				50V	25V	50V	25V	50V	25V	50V	25V
0704	0.070 (1.78)	0.040 (1.02)	0.040 (1.02)	680 pF	820 pF	6800 pF	0.012 µF	0.018 µF	0.022 µF	0.027 µF	0.039 µF
0905	0.100 (2.54)	0.050 (1.27)	0.050 (1.27)	1800 pF	2200 pF	0.018 µF	0.033 µF	0.047 µF	0.068 µF	0.12 µF	0.18 µF
0907	0.090 (2.29)	0.070 (1.78)	0.050 (1.27)	2700 pF	3300 pF	0.068 µF	0.10 µF	0.10 µF	0.12 µF	0.22 µF	0.27 µF
1505	0.150 (3.81)	0.050 (1.27)	0.050 (1.27)	3300 pF	3900 pF	0.047 µF	0.082 µF	0.10 µF	0.12 µF	0.22 µF	0.27 µF
1706	0.170 (4.32)	0.065 (1.65)	0.065 (1.65)	4700 pF	8200 pF	0.10 µF	0.15 µF	0.18 µF	0.22 µF	0.47 µF	0.68 µF
1808	0.180 (4.57)	0.080 (2.03)	0.065 (1.65)	0.010 µF	0.012 µF	0.15 µF	0.22 µF	0.33 µF	0.39 µF	1.0 µF	1.2 µF
2018	0.197 (5.00)	0.180 (4.57)	0.080 (2.03)	0.027 µF	0.033 µF	0.47 µF	0.56 µF	0.56 µF	0.68 µF	2.2 µF	2.7 µF
2321	0.225 (5.72)	0.210 (5.33)	0.070 (1.78)	0.047 µF	0.056 µF	0.68 µF	0.82 µF	0.82 µF	1.0 µF	2.7 µF	3.3 vF
2708	0.270 (6.85)	0.080 (2.03)	0.070 (1.78)	0.010 µF	0.012 µF	0.22 µF	0.27 µF	0.39 µF	0.47 µF	1.2 µF	1.5 µF
2725	0.270 (6.85)	0.250 (6.35)	0.055 (1.40)	0.05 µF	0.060 µF			2.0 µF	2.2 µF		
3439	0.340 (8.64)	0.390 (9.91)	0.060 (1.52)	0.082 µF	0.100 µF			3.3 µF	3.9 µF		
3736	0.370 (9.40)	0.360 (9.14)	0.060 (1.52)	0.100 µF	0.120 µF			4.0 µF	4.7 µF		
3941	0.390 (9.91)	0.410 (10.41)	0.060 (1.52)	0.150 µF	0.180 µF			6.0 µF	6.8 µF		
4036	0.400 (10.16)	0.360 (9.14)	0.060 (1.52)	0.120 µF	0.150 µF			5.0 µF	5.6 µF		
4540	0.450 (11.43)	0.400 (10.16)	0.060 (1.52)	0.180 µF	0.200 µF			6.8 µF	7.8 µF		
5595	0.550 (13.97)	0.950 (24.13)	0.070 (1.78)	0.270 µF	0.300 µF			10.0 µF	12.0 µF		
5930	0.585 (14.86)	0.298 (7.57)	0.070 (1.78)	0.150 µF	0.180 µF			6.0 µF	6.8 µF		

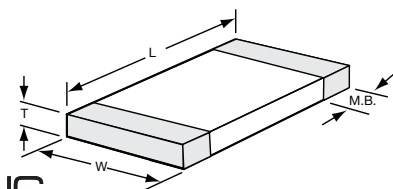

7169 Construction Court, San Diego, CA 92121 • Tel: 1+858-578-9390 • Fax: 1+858-578-6225
www.presidiocomponents.com • email: info@presidiocomponents.com

HOW TO ORDER CDR QPL MIL-PRF-55681 PARTS

(See spec on DLA website.)

CDR01		BX		472		B		K		M		S	
Military Size & Style 0805		Dielectric Code VTC = +15% / -25%		Capacitance Code 4700pF (see page 14)		Rated Voltage 100V		Capacitance Tolerance ± 10%		Termination Finish PdAg		Product Level Code Failure Rate S = 0.001% per 1000 hrs.	
MIL-PRF-55681 Style	Case Size	Dielectric Codes	Voltage Temp. Limits	Voltage Codes	Rated Voltage	Tolerance Codes	Cap. Tolerance	Termination Finish Codes	Finish	Prod. Level Codes	Failure Rate		
01	0805	BP	0 ± 30ppm/°C	A	50 V	F	± 1%	M	Palladium/silver alloy	C	non-ER		
02	1805	BX	+15% / -25%	B	100 V	G	± 2%	N	Silver - nickel - gold	M	1% per 1000 hrs.		
03	1808						J	± 5%	S	Solder coated final w/min. of 3% lead	P	0.1% per 1000 hrs.	
04	1812					K	± 10%	T	Silver	R	0.01% per 1000 hrs.		
05	1825					M	± 20%	U	Base metalization - nickel - solder coated (tin/lead alloy, w/min. 3% lead)	S	0.001% per 1000 hrs.		
06	2225							Z	Base metalization - nickel - solder plated (tin/lead alloy, w/min. 3% lead)				
31	0805												
32	1206												
33	1209												
34	1812												
35	1725												

Capacitance Codes			
Two significant figures followed by the number of zeros. Examples:			
0R1 = 0.1 pF	102 = 1000 p		
1R0 = 1.0 pF	103 = .01 μF		
100 = 10 pF	104 = .10 μF		
101 = 100 pF	105 = 1.0 μF		

For information on CDR 11, 12, 13, & 14, please consult our [Pages from the NPO Capacitor 7100 Catalog](#).

HOW TO ORDER M123 QPL PARTS

(See spec on DLA website.)

M123A		10		BX		B		103		K		Z	
Performance Spec. No. & Modification		Slash Sheet No.		Dielectric Code VTC = +15% / -25%		Voltage Code 50V		Capacitance Code 0.01μF (see page 15)		Cap. Tolerance Code ± 10%		Termination Finish Ni/SnPb	
MIL-PRF-123 Slash Sheet	Case Size	Dielectric Codes	Voltage Temp. Limits	Voltage Codes	Rated Voltage	Tolerance Codes	Cap. Tolerance	Termination Finish Codes	Finish				
10	0805	BP	0 ± 30ppm/°C	B	50 V	B	± 0.1 pF	G	Silver - nickel - gold				
11	1210	BX	+15 / -25%	C	100 V	C	± 0.25 pF	M	Palladium/silver alloy				
12	1808							D	± 0.5 pF	S	Silver - Nickel - Solder coated		
13	2225					F	± 1%	Z	Silver - Nickel - Solder plated				
21	1206					G	± 2%						
22	1812					J	± 5%						
23	1825					K	± 10%						
						M	± 20%						

Capacitance Codes			
Two significant figures followed by the number of zeros. Examples:			
0R1 = 0.1 pF	102 = 1000 p		
1R0 = 1.0 pF	103 = .01 μF		
100 = 10 pF	104 = .10 μF		
101 = 100 pF	105 = 1.0 μF		

Note: Tin/lead alloy with a minimum of 3 percent lead for termination finish S and Z

ELECTRICAL CHARACTERISTICS

Dielectric Type	Rated Voltage (V)	Temperature Coefficient (TC) from -55° to +125°C Bias = 0 Volt	Temperature Voltage Coefficient (VTC) from -55° to +125°C Bias = Rated Voltage
NPO	ALL	± 30 PPM	NOT SPECIFIED
BP	ALL	± 30 PPM	± 30 PPM
BX	25/50/100	±15%	+15, -25%
BR	200	±15%	+15, -40%
BQ	500	±15%	+15, -50%
X7R	ALL	±15%	NOT SPECIFIED

STORAGE RECOMMENDATIONS

MOISTURE SENSITIVITY LEVEL: MSL1
ESD SENSITIVITY: NONE
RECOMMENDED STORAGE CONDITIONS (for unmounted parts):
 Ceramic capacitors should be stored indoors, in their original packaging, in a controlled temperature of 5 to 30°C (41 to 86°F) and a relative humidity below 60%. We recommend checking the solderability after 12 months of storage.



MIL-PRF-55681 CDR CHIP CAPACITORS

(Consult DLA website for the latest revision)

SIZE/MIL-PRF-55681	0805/CDR01			1805/CDR02			1808/CDR03			1812/CDR04			1825/CDR05			2225/CDR06		0805/CDR31				1206/CDR32				1210/CDR33				1812/CDR34				1825/CDR35					
	DIELECTRIC		BP	BX	BX	BP	BX	BX	BP	BX	BX	BP	BX	BX	BP	BX	BX	BP	BP	BX	BX	BP	BP	BX	BX	BP	BP	BX	BX	BP	BP	BX	BX	BP	BP	BX	BX		
WVDC	100	100	50	100	100	50	100	100	50	100	100	50	100	100	50	100	50	100	50	100	50	100	50	100	50	100	50	100	50	100	50	100	50	100	50	100	50		
pF / μ F	CODE																																						
See CDR31&32 Note	Lower Cap Values Available: 1.0 to 9.1 pF																																						
10	100																																						
11	110																																						
12	120																																						
13	130																																						
15	150																																						
16	160																																						
18	180																																						
20	200																																						
22	220																																						
24	240																																						
27	270																																						
30	300																																						
33	330																																						
36	360																																						
39	390																																						
43	430																																						
47	470																																						
51	510																																						
56	560																																						
62	620																																						
68	680																																						
75	750																																						
82	820																																						
91	910																																						
100	101																																						
110	111																																						
120	121																																						
130	131																																						
150	151																																						
160	161																																						
180	181																																						
200	201																																						
220	221																																						
240	241																																						
270	271																																						
300	301																																						
330	331																																						
360	361																																						
390	391																																						
430	431																																						
470	471																																						
510	511																																						
560	561																																						
620	621																																						
680	681																																						
750	751																																						
820	821																																						
910	911																																						
1000	102																																						
1100	112																																						
1200	122																																						
1300	132																																						
1500	152																																						
1600	162																																						
1800	182																																						
2000	202																																						
2200	222																																						
2400	242																																						
2700	272																																						
3000	302																																						
3300	332																																						
3600	362																																						
3900	392																																						
4300	432																																						
4700	472																																						
5100	512																																						
5600	562																																						
6200	622																																						
6800	682																																						
7500	752																																						
8200	822																																						
9100	912																																						
0.010	103																																						
0.011	113																																						
0.012	123																																						
0.013	133																																						
0.015	153																																						
0.016	163																																						
0.018	183																																						
0.020	203																																						
0.022	223																																						
0.027	273																																						
0.033	333																																						
0.039	393																																						
0.047	473																																						
0.056	563																																						
0.068	683																																						
0.082	823																																						
0.10	104																																						
0.12	124																																						
0.15	154																																						
0.18	184																																						
0.22	224																																						
0.27	274																																						
0.33	334																																						
0.39	394																																						
0.47	474																																						

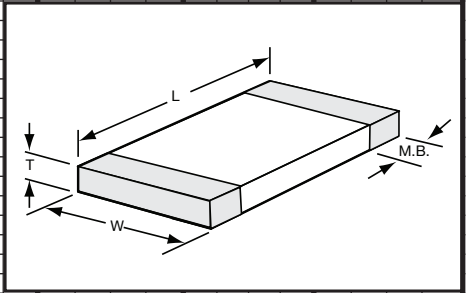

For information on CDR 11, 12, 13, & 14, please consult our Pages from the NPO Capacitor Catalog.

μ F starts

MIL-PRF-123 CKS CHIP CAPACITORS

(Consult DLA website for the latest revision)

SIZE		0805		1206		SIZE		0805		1206		1210		1808		1812		1825		2225	
SLASH SHEET:		10E		21D		SLASH SHEET:		10E		21D		11F		12E		22D		23C		13F	
M123		CKS51		CKS55		M123		CKS51		CKS55		CKS52		CKS53		CKS56		CKS57		CKS54	
L inch (mm)		0.080 (2.03)		0.126 (3.20)		L inch (mm)		0.080 (2.03)		0.126 (3.20)		0.120 (3.05)		0.180 (4.57)		0.180 (4.57)		0.180 (4.57)		0.225 (5.72)	
W inch (mm)		0.065 (1.27)		0.063 (1.60)		W inch (mm)		0.065 (1.27)		0.063 (1.60)		0.100 (2.54)		0.080 (2.03)		0.125 (3.18)		0.255 (6.35)		0.250 (6.35)	
T MAX. inch (mm)		0.055 (1.40)		0.059 (1.50)		T MAX. inch (mm)		0.055 (1.40)		0.059 (1.50)		0.065 (1.65)		0.065 (1.65)		0.080 (2.03)		0.080 (2.03)		0.070 (1.78)	
M.B. inch (mm)		0.020 (0.51)		0.020 (0.51)		M.B. inch (mm)		0.020 (0.51)		0.020 (0.51)		0.020 (0.51)		0.020 (0.51)		0.020 (0.51)		0.020 (0.51)		0.020 (0.51)	
DIELECTRIC		BP BP		BP BP		DIELECTRIC		BP BP BX BX		BP BP BX BX		BP BP BX BX		BP BP BX BX		BP BP BX BX		BP BP BX BX		BP BX	
WVDC		100 50		100 50		WVDC		100 50 100 50		100 50 100 50		100 50 100 50		100 50 100 50		100 50 100 50		100 50 100 50		50 50	
pF	CODE					pF/μF	CODE														
1.0	1R0					300	301														
1.1	1R1					330	331														
1.2	1R2					360	361														
1.3	1R3					390	391														
1.5	1R5					430	431														
1.6	1R6					470	471														
1.8	1R8					510	511														
2.0	2R0					560	561														
2.2	2R2					620	621														
2.4	2R4					680	681														
2.7	2R7					750	751														
3.0	3R0					820	821														
3.3	3R3					910	911														
3.6	3R6					1000	102														
3.9	3R9					1100	112														
4.3	4R3					1200	122														
4.7	4R7					1300	132														
5.1	5R1					1500	152														
5.6	5R6					1600	162														
6.2	6R2					1800	182														
6.8	6R8					2000	202														
7.5	7R5					2200	222														
8.2	8R2					2400	242														
9.1	9R1					2700	272														
10	100					3000	302														
11	110					3300	332														
12	120					3600	362														
13	130					3900	392														
15	150					4300	432														
16	160					4700	472														
18	180					5100	512														
20	200					5600	562														
22	220					6200	622														
24	240					6800	682														
27	270					7500	752														
30	300					8200	822														
33	330					9100	912														
39	390					0.010	103														
43	430					0.011	113														
47	470					0.012	123														
51	510					0.013	133														
56	560					0.015	153														
62	620					0.016	163														
68	680					0.018	183														
75	750					0.020	203														
82	820					0.022	223														
91	910					0.027	273														
100	101					0.033	333														
110	111					0.039	393														
120	121					0.047	473														
130	131					0.056	563														
150	151					0.068	683														
160	161					0.082	823														
180	181					0.10	104														
200	201					0.12	124														
220	221					0.15	154														
240	241					0.18	184														
270	271					0.22	224														
						0.27	274														
						0.33	334														
						0.39	394														
						0.47	474														
						1	105														

μF starts
↓

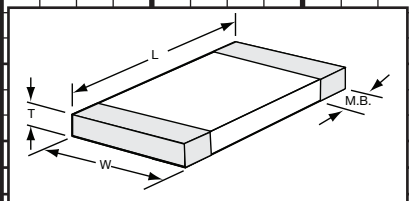

HOW TO ORDER A QPL MIL-PRF-123 PART (See spec on DLA website. Example: M123B10BXB103KZ)

M123A	10	BX	B	103	K	Z
Performance Spec. No.	Slash Sheet No.	Dielectric Code VTC = +15% / -40%	Voltage Code 50 V	Capacitance 0.01 μF	Tolerance Code ± 10%	Termination Finish Ni/SnPb

PRESIDIO PRODUCT LINES

100% U.S. MADE, 100% U.S. OWNED

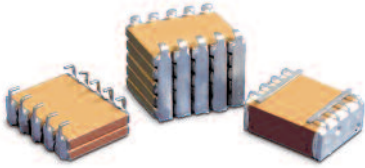

STACKS WITH INTERDIGITATED LEADS

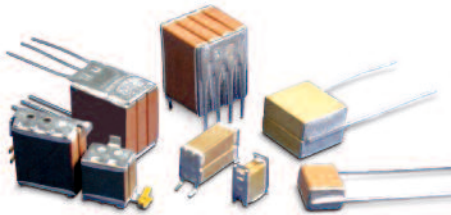

OPTIMIZED STACKED ASSEMBLY



HIGH FREQUENCY HIGH POWER STACKS

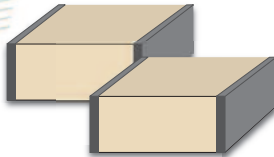

HIGH Q NPO RF CAPACITORS

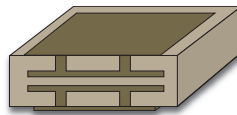

SMALLEST & BEST IN CLASS WIREBONDABLE SINGLE LAYER

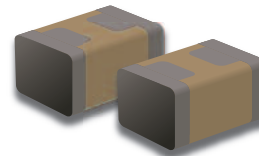

SMD BROADBAND DC BLOCK BB SERIES

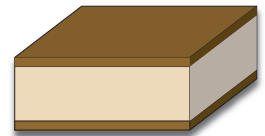

WIREBONDABLE BYPASS (VL Series) BROADBAND BYPASS (VB Series)

PRESIDIO COMPONENTS, INC. maintains more than 100 million commercial and military parts in inventory. We also offer multitudes of intermediate sizes, voltages, tolerances, termination finishes, lead-frame styles and more.

Some of our specialties include ceramic capacitors for high temperatures, cryogenic temperatures, pulse discharge applications as well as high Q dielectric, negative and positive temperature characteristic and piezoelectric ceramic formulations.

Backed with numerous patents and hundred of years of combined experience, Presidio is well suited to offer a solution to your demanding applications. Please contact our engineering team to discuss your specific needs.

100% U.S. Made, 100% U.S. Owned



'S' LEAD STACKS

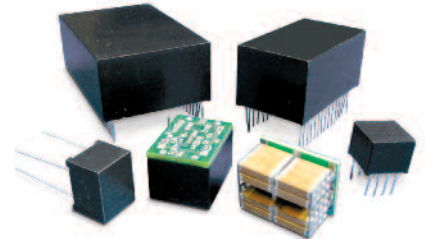

ENCAPSULATED STACKS

MAIN PRODUCT CATALOGS

Click Catalog Cover or Scan QR Code to Visit Product Page on Website



SURFACE MOUNT CERAMIC CHIP CAPACITORS



HIGH RELIABILITY EXTENDED RANGE CHIPS FOR SPACE



CERAMIC STACKED CAPACITORS FOR SMPS



HIGH TEMPERATURE CERAMIC CAPACITORS

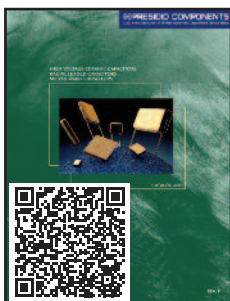

HIGH VOLTAGE RADIAL LEADED & MIL-PRF-49467 CERAMIC CAPACITORS

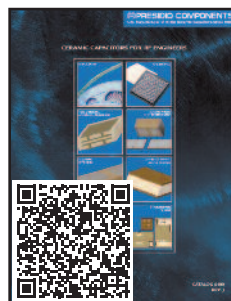

CERAMIC CAPACITORS FOR RF ENGINEERS

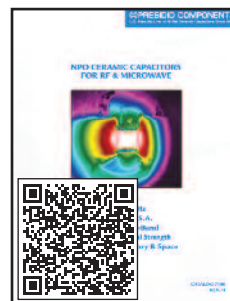

HIGH Q NPO CERAMIC CAPACITORS FOR RF & MICROWAVE

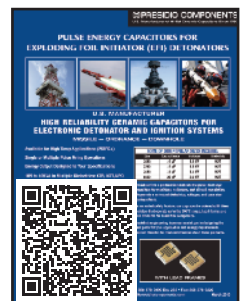

PULSE DISCHARGE CERAMIC CAPACITORS

Information in this document is subject to change without notice.



PRESIDIO COMPONENTS, INC.

7169 Construction Court, San Diego, CA 92121 • Tel: 1+858-578-9390 • Fax: 1+858-578-6225

www.presidiocomponents.com • email: info@presidiocomponents.com

CATALOG 5001, REV. K
NOVEMBER 2023